

Ultra Low capacitance double Uni-directional ESD protection diodes

The MESD05N92ULA device is characterized by their ultra low capacitance, low operating and clamping voltages, and fast response time. This makes it ideal for use as board level protection of sensitive semiconductor components. The dual-junction common-anode design allows the user to protect two bidirectional lines.

It has been specifically designed to protect sensitive components which are connected to data and transmission lines from overvoltage caused by ESD(electrostatic discharge), CDE (Cable Discharge Events),and EFT (electrical fast transients).

Features

- Ultra small package(DFN1006) for use in portable electronics
- ESD protection of two lines
- Ultra Low leakage current
- Ultra Low capacitance: $C_j=0.45\text{pF}$ typ
- Response Time is $< 1\text{ ns}$
- Working voltages :5.5V
- Solid-state silicon avalanche technology
- Device Meets MSL 1 Requirements
- ROHS compliant

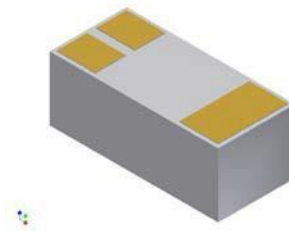

DFN1006-3L

Main applications

- USB1.1/2.0/3.0/3.1 Data lines
- HDMI 2.0
- Industrial Controls
- Computers and peripherals
- Portable instrumentation
- Notebook Computers
- DVI
- Projection TV
- Audio and video equipment
- Subscriber Identity Module (SIM) card protection

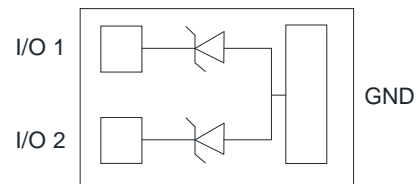

Protection solution to meet

- IEC61000-4-2 (ESD): $\pm 15\text{kV}$ (air), $\pm 8\text{kV}$ (contact)
- IEC61000-4-4 (EFT): 40A (5/50ns)

Ordering Information

Device	Qty per Reel	Reel Size
MESD05N92ULA	10000	7 Inch



Maximum ratings (Tamb=25°C Unless Otherwise Specified)

Parameter	Symbol	Value	Unit
ESD Rating per IEC61000-4-2:	Contact	15	KV
	Air	15	
Lead Soldering Temperature	T _L	260 (10 sec.)	°C
Operating Temperature Range	T _J	-55 ~ 150	°C
Storage Temperature Range	T _{STG}	-55 ~ 150	°C

Maximum ratings are those values beyond which device damage can occur. Maximum ratings applied to the device are individual stress limit values (not normal operating conditions) and are not valid simultaneously. If these limits are exceeded, device functional operation is not implied, damage may occur and reliability may be affected.

*Other voltages may be available upon request.

1. Non-repetitive current pulse, per Figure 1.

Electrical characteristics (Tamb=25°C Unless Otherwise Specified)

Symbol	Parameter	Conditions	Min.	Typ.	Max.	Units
V _{RWM}	Reverse Working Voltage	any I/O pin to Ground			5.5	V
V _{BR}	Reverse Breakdown Voltage	I _T = 0.1mA	6.0			V
I _{RM}	Reverse Leakage Current	V _{RWM} = 5.5V			0.1	uA
V _F	Forward Voltage	I _T = 15mA Pin3 to Pin1、Pin2		0.9	1.2	V
V _C	Clamping Voltage	I _{PP} = 3A, t _p = 8/20μs;			9.8	V
C _J	Junction Capacitance	V _R = 0V, f = 1MHz Any I/O pin to Ground		0.45	0.65	pF

Symbol	Parameter
V _{RWM}	Working Peak Reverse Voltage
V _{BR}	Breakdown Voltage @ I _T
V _C	Clamping Voltage @ I _{PP}
I _T	Test Current
I _{RM}	Leakage current at V _{RWM}
I _{PP}	Peak pulse current
C _O	Off-state Capacitance
C _J	Junction Capacitance

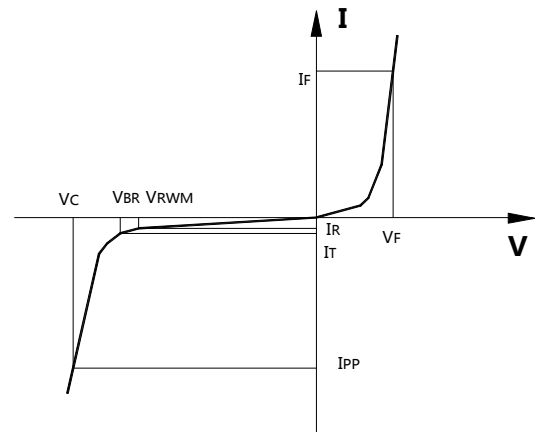

Typical electrical characterist applications

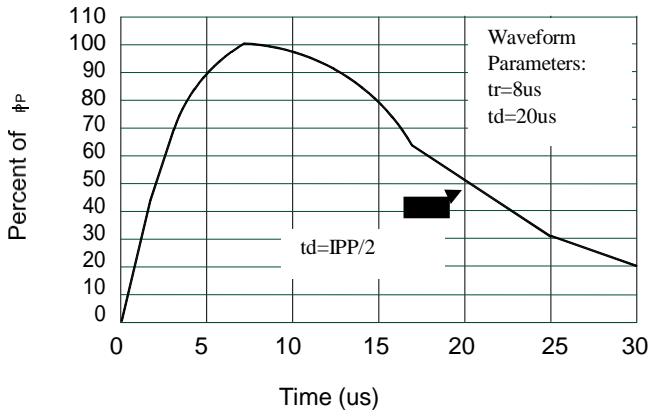

Pulse Waveform

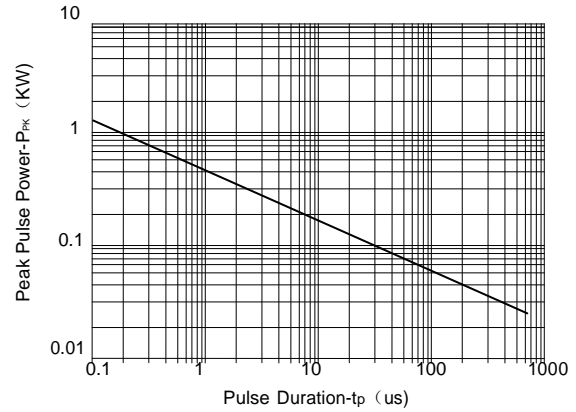

Non-Repetitive Peak Pulse Power vs. Pulse Time

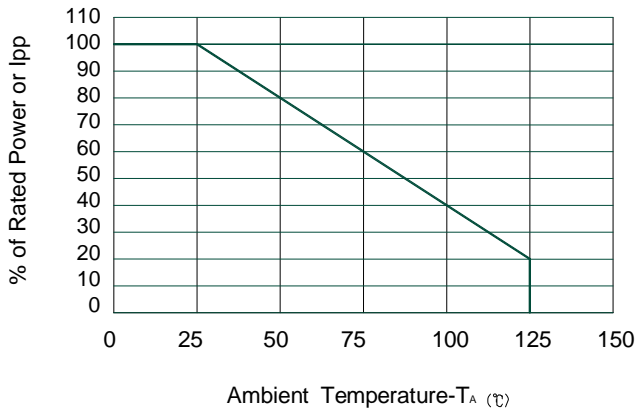

Power Derating Curve

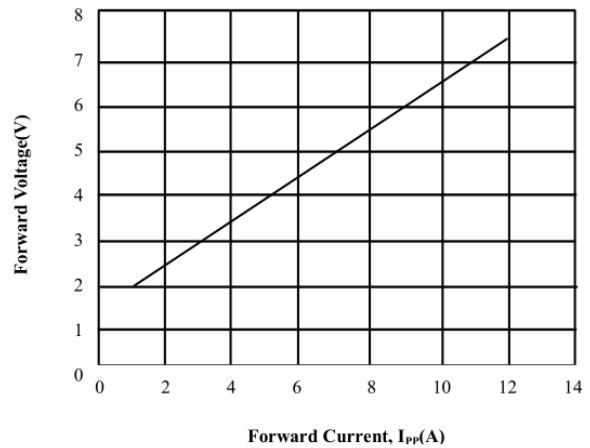

Forward Voltage vs. Forward Peak Pulse Current
 ($t_{period}=100ns, t_r=1ns$)

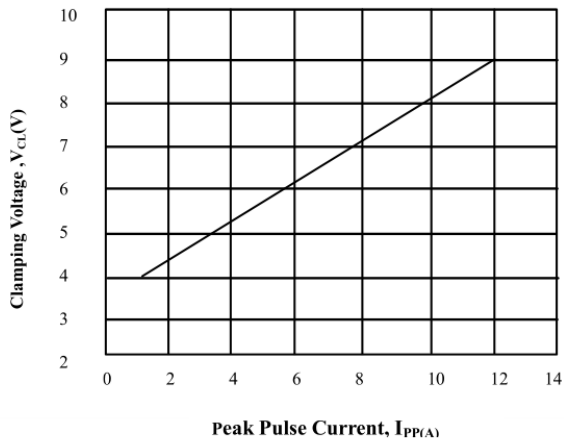

Clamping Voltage vs. Peak Pulse Current
 ($t_{period}=100ns, t_r=1ns$)

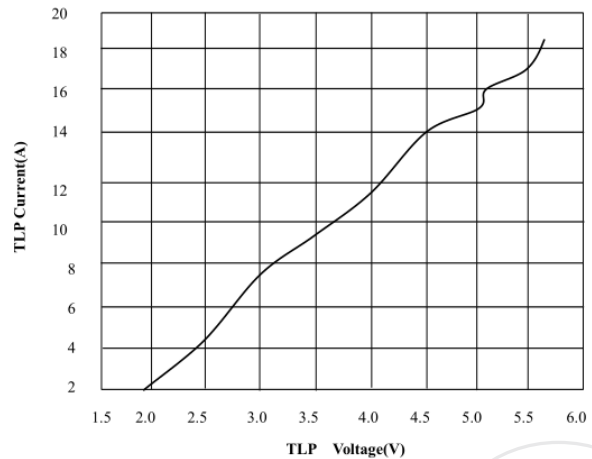

Transmission Line Pulsing (TLP) Measurement



Package information

DFN1006-3L

Mechanical Data

Case: DFN1006-3L

Case Material: Molded Plastic. UL Flammability

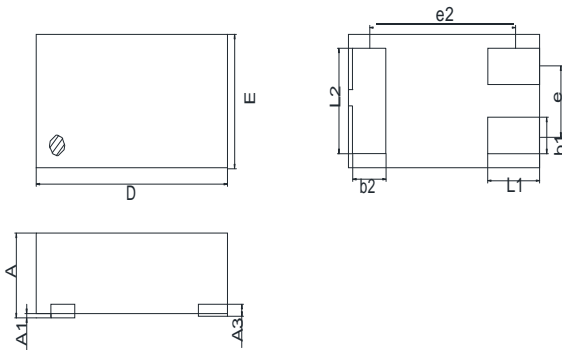

Dim	Millimeters		Inches	
	Min	Max	Min	Max
A	0.40	0.55	0.016	0.022
A1	0.01	0.10	0.0004	0.004
A3	0.125REF		0.005REF	
D	0.95	1.05	0.037	0.041
E	0.55	0.65	0.022	0.026
b1	0.10	0.20	0.004	0.008
b2	0.20	0.30	0.008	0.012
L1	0.20	0.40	0.008	0.016
L2	0.40	0.60	0.016	0.024
e1	0.30	0.40	0.012	0.016
e2	0.675BSC		0.027BSC	

Pad Layout

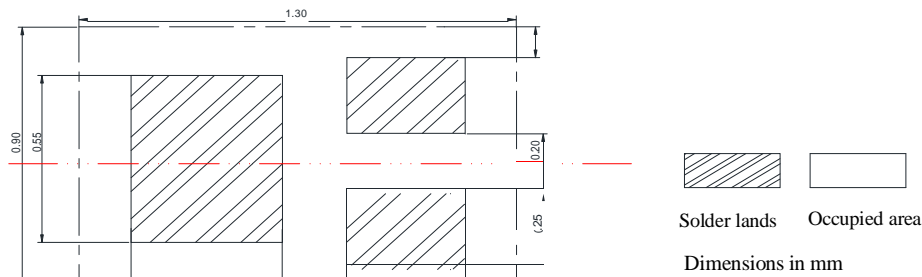

DFN1006-3L Reel Dim

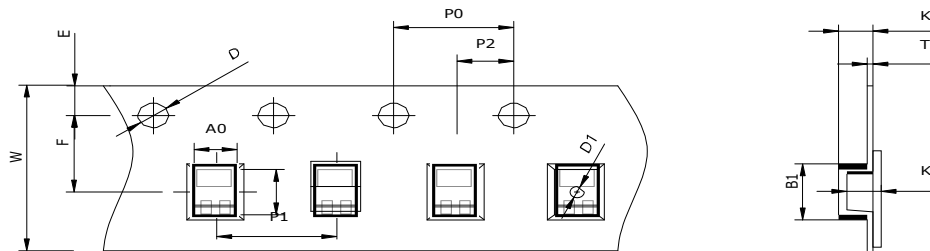

Package	Chip Size (mm)	Pocket Size B0xA0xK0(mm)	Tape Width	Reel Diameter	Quantity Per Reel	P0	P1
DFN1006-3L	1.55×1.45×0.55	1.65×1.55×0.65	8mm	178mm(7")	10000	4mm	2mm
D0	D1	E	F	K	T	W	
1.5mm	-	1.75mm	3.5mm	0.60mm	0.3mm	8mm	