

Low-Capacitance Bidirectional Micro Packaged TVS Diodes for ESD Protection

The MESD3311P2 is designed with TVS technology to protect voltage sensitive components from ESD. Excellent clamping capability, low leakage, and fast response time provide best in class protection on designs that are exposed to ESD. Because of its small size, it is suited for use in cellular phones, MP3 players, digital cameras and many other portable applications where board space comes at a premium.

It has been specifically designed to protect sensitive components which are connected to data and transmission lines from overvoltage caused by ESD(electrostatic discharge), and EFT (electrical fast transients).

Features

- Peak Power Dissipation –60 W (8 x 20 us Waveform)
- Stand-off Voltage: 3.3 V
- Replacement for MLV (0402)
- Protects I/O or Power Port
- Low Clamping Voltage
- Low Leakage
- Response Time is < 1 ns
- Meets MSL 1 Requirements
- ROHS compliant
- Solid-state Punch-Through TVS Process technology



DFN1006

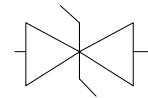

Main applications

- Serial and Parallel Ports
- Notebooks, Desktops, Servers
- Projection TV
- Cellular handsets and accessories
- Portable instrumentation
- Peripherals
- MP3 Players

Protection solution to meet

- IEC61000-4-2 (ESD) ±30kV (air), ±30kV (contact)
- IEC61000-4-5 (Lightning)7A (8/20μs)

Ordering Information

Device	Qty per Reel	Reel Size
MESD3311P2	10000	7 Inch

DCC
正式發行

Maximum ratings (Tamb=25°C Unless Otherwise Specified)

Parameter	Symbol	Value	Unit
Peak Pulse Power (tp=8/20μs waveform)	P _{PPP}	60	Watts
ESD Rating per IEC61000-4-2:	Contact	20	KV
	Air	20	
Lead Soldering Temperature	T _L	260 (10 sec.)	°C
Operating Temperature Range	T _J	-55 ~ 150	°C
Storage Temperature Range	T _{STG}	-55 ~ 150	°C
Lead Solder Temperature – Maximum (10 Second Duration)	T _L	260	°C

Maximum ratings are those values beyond which device damage can occur. Maximum ratings applied to the device are individual stress limit values (not normal operating conditions) and are not valid simultaneously. If these limits are exceeded, device functional operation is not implied, damage may occur and reliability may be affected.

*Other voltages may be available upon request.

1. Non-repetitive current pulse, per Figure 1.

Junction capacitance is measured in VR=0V, F=1MHz

Electrical characteristics (Tamb=25°C Unless Otherwise Specified)

Symbol	Parameter	Conditions	Min.	Typ.	Max.	Units
V _{RWM}	Reverse Working Voltage				3.3	V
V _{BR}	Reverse Breakdown Voltage	I _T = 1mA,	4.0			V
I _R	Reverse Leakage Current	V _{RWM} = 3.3V,		0.05	1	μA
V _C	Clamping Voltage	I _{PP} = 1A, tp =8/20μs,			7.6	V
		I _{PP} = 7A, tp =8/20μs,		9	15	V
C _J	Junction Capacitance	V _R = 0V, f = 1MHz,		18	25	pF

Symbol	Parameter
V _{RWM}	Working Peak Reverse Voltage
V _{BR}	Breakdown Voltage @ I _T
V _C	Clamping Voltage @ I _{PP}
I _T	Test Current
I _{RM}	Leakage current at V _{RWM}
I _{PP}	Peak pulse current
C _O	Off-state Capacitance
C _J	Junction Capacitance

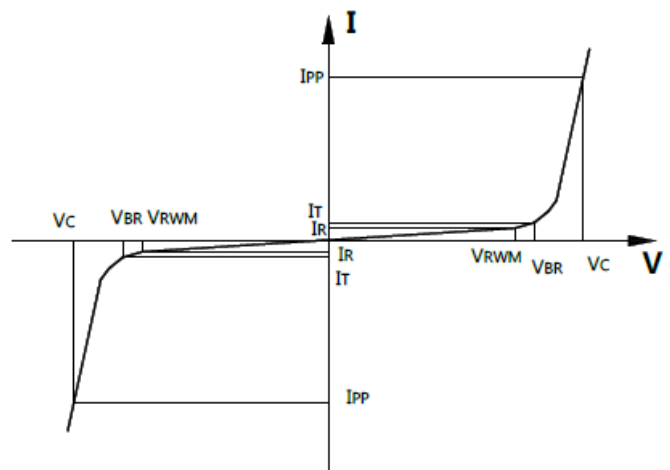

Typical electrical characterist applications

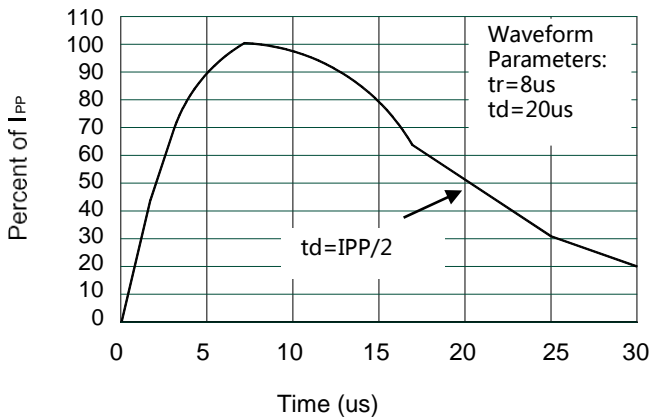

Pulse Waveform

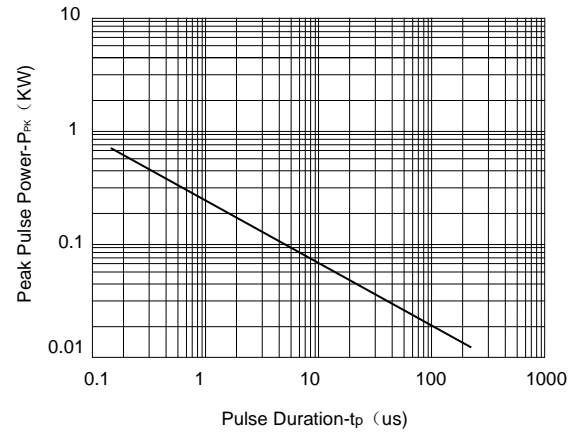

Non-Repetitive Peak Pulse Power vs. Pulse Time

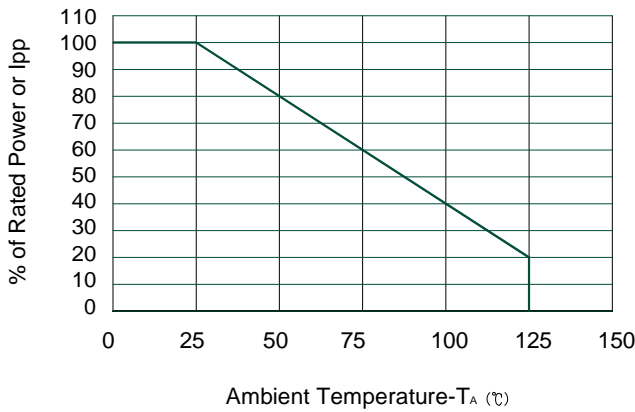

Power Derating Curve

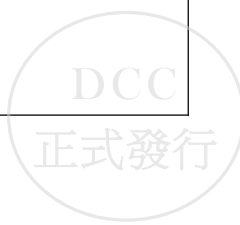
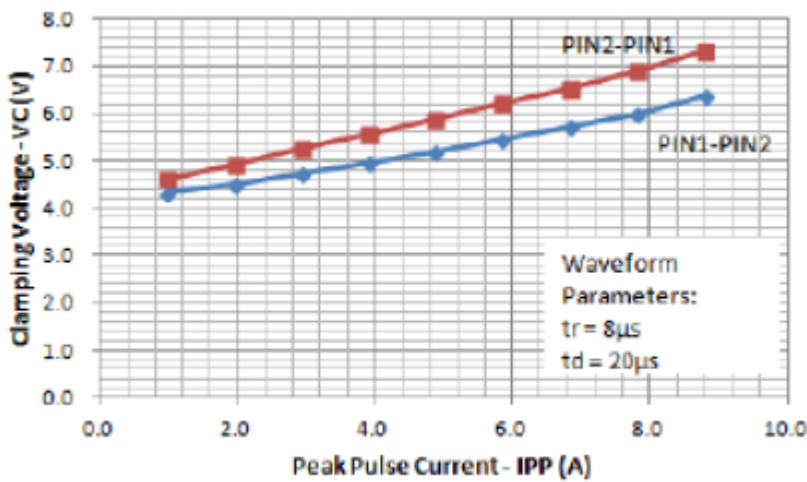

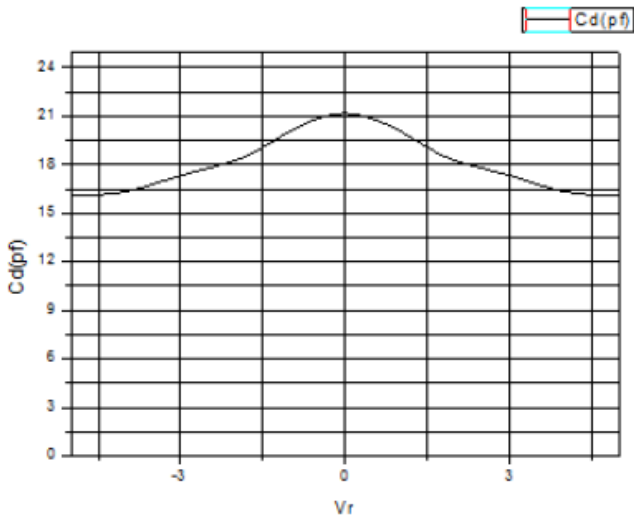

Capacitance vs Bias Voltage Curve

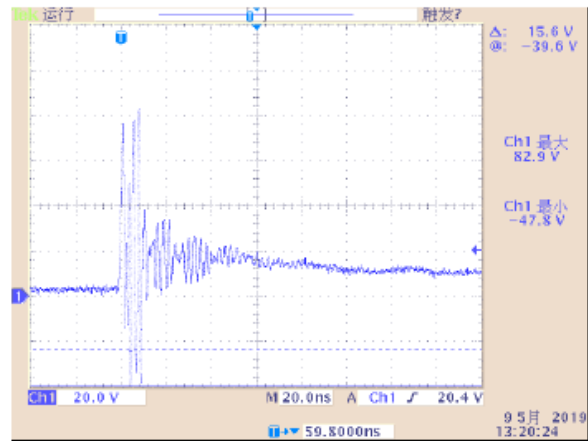

8KV IEC Waveform

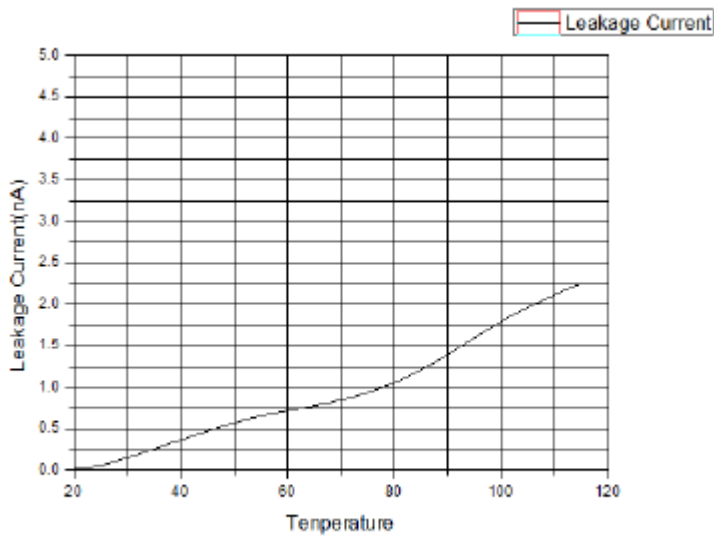

Leakage Current vs. Curve

DCC
正式發行

Package Information

DFN-1006

Mechanical Data

Case:DFN1006

Case Material: Molded Plastic. UL
Flammability

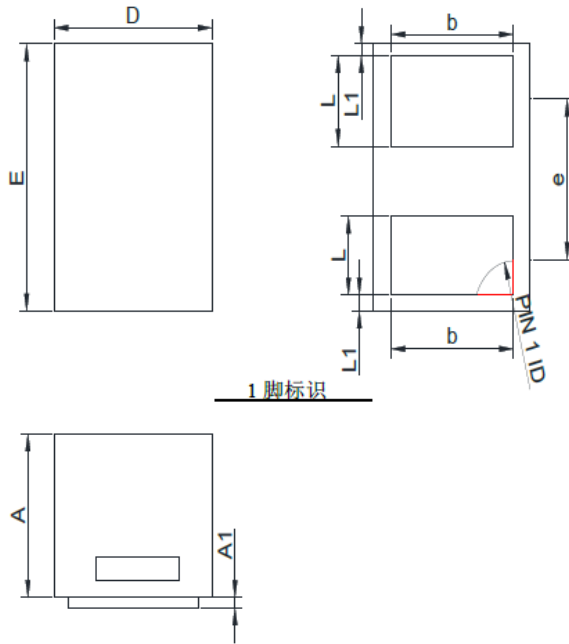

DIM	Millimeters	
	Min	Max
A	0.30	0.50
A1	0.00	0.05
D	0.55	0.65
E	0.95	1.05
b	0.25	0.60
e	0.65TYP	
L	0.15	0.35
L1	0.05REF	



Soldering Footprint

Packing information

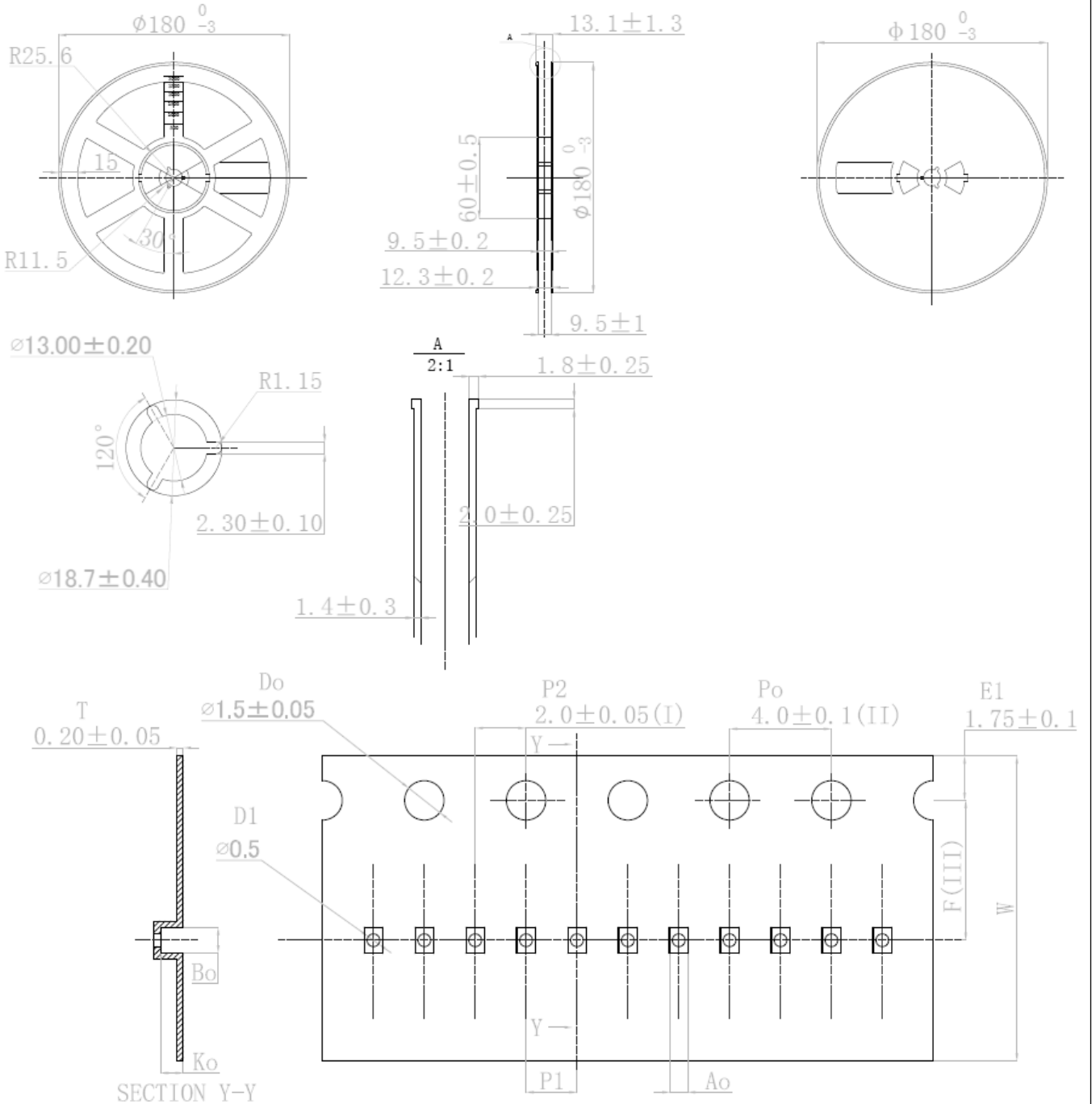

Package	Chip Size	Pocket Size Bo x Ao x Ko	Tape Width	Reel Diameter	Quantity Per Reel	Po	P1
DFN1006	1.0x0.6x0.5	1.1x0.7x0.6	8mm	178mm (7")	10K	4mm	2mm
Do	D1	E1	F	Ko	T	W	
1.5mm	0.5mm	1.75mm	3.5mm	0.6mm	0.2mm	8mm	

